

ET rocket
nozzles

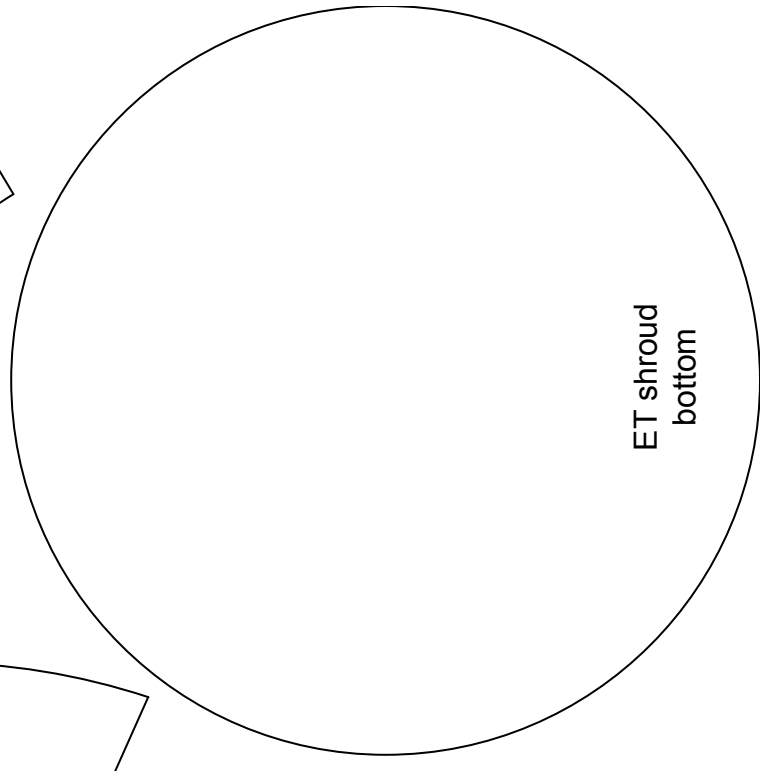

ET shroud
bottom

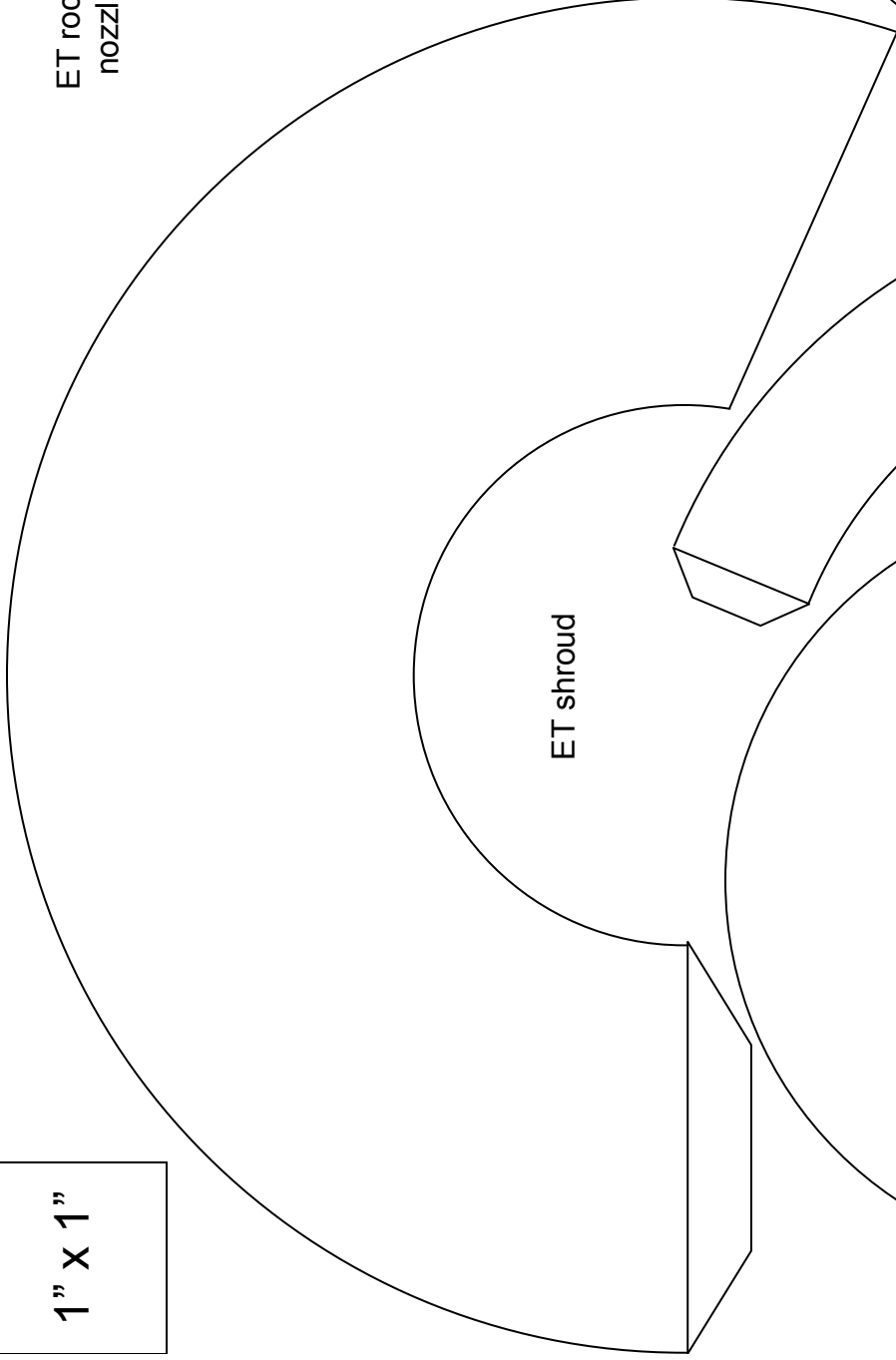

ET shroud

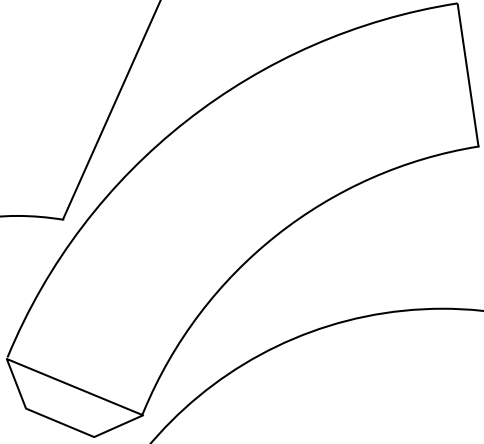

ET shroud
top

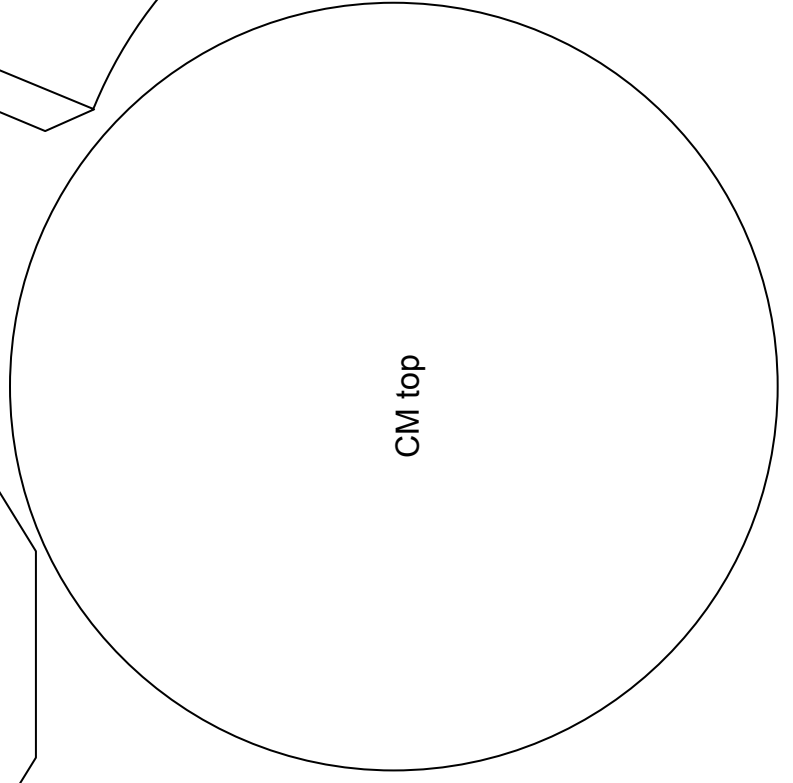
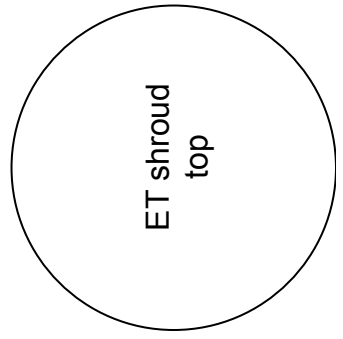

CM top

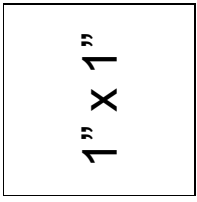

1" X 1"

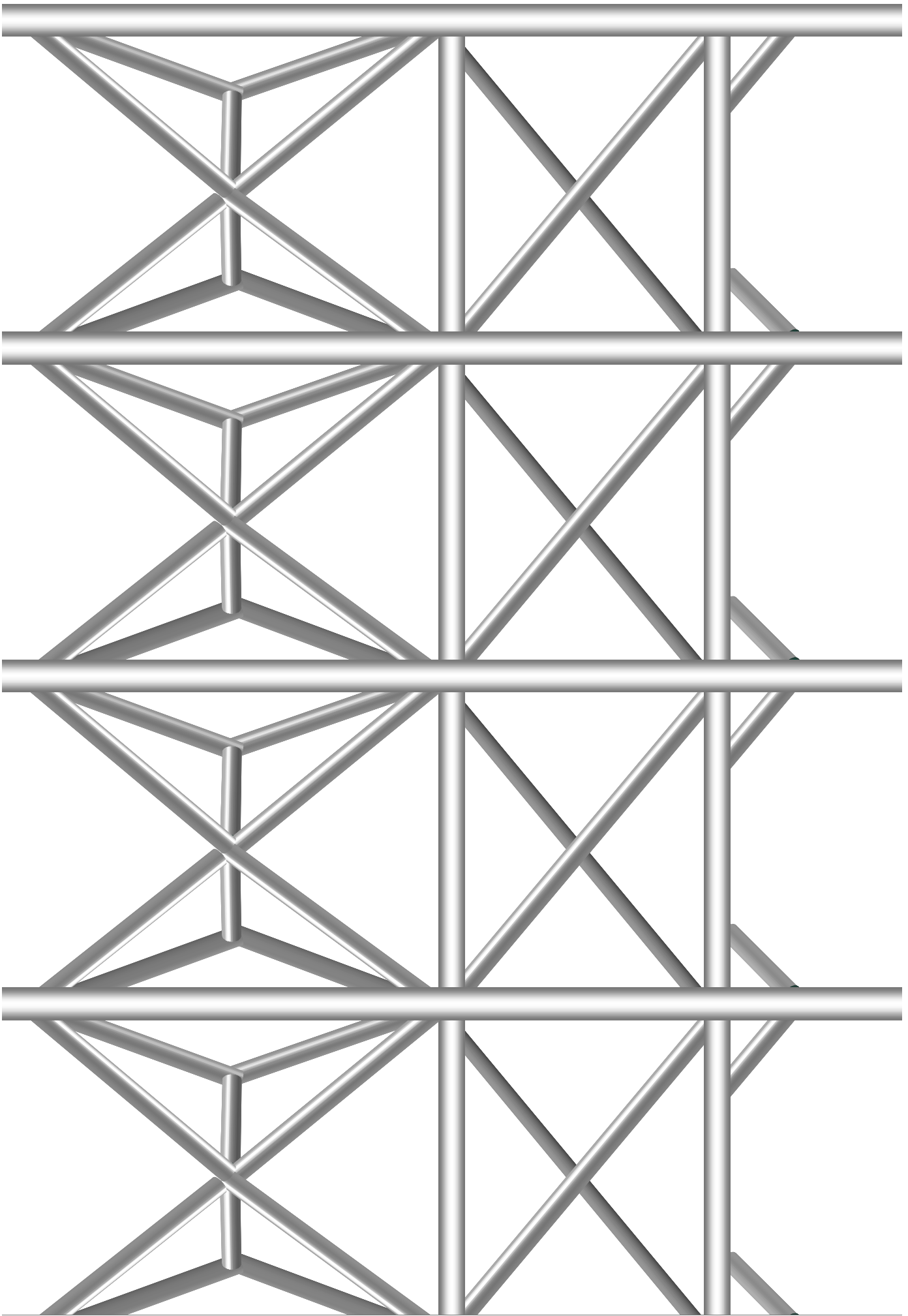

1" X 1"

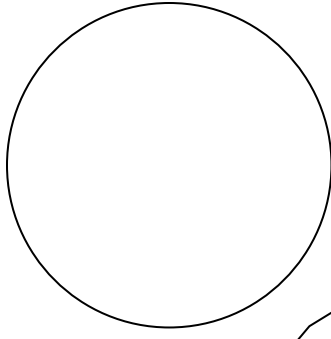

Fuel Cell End

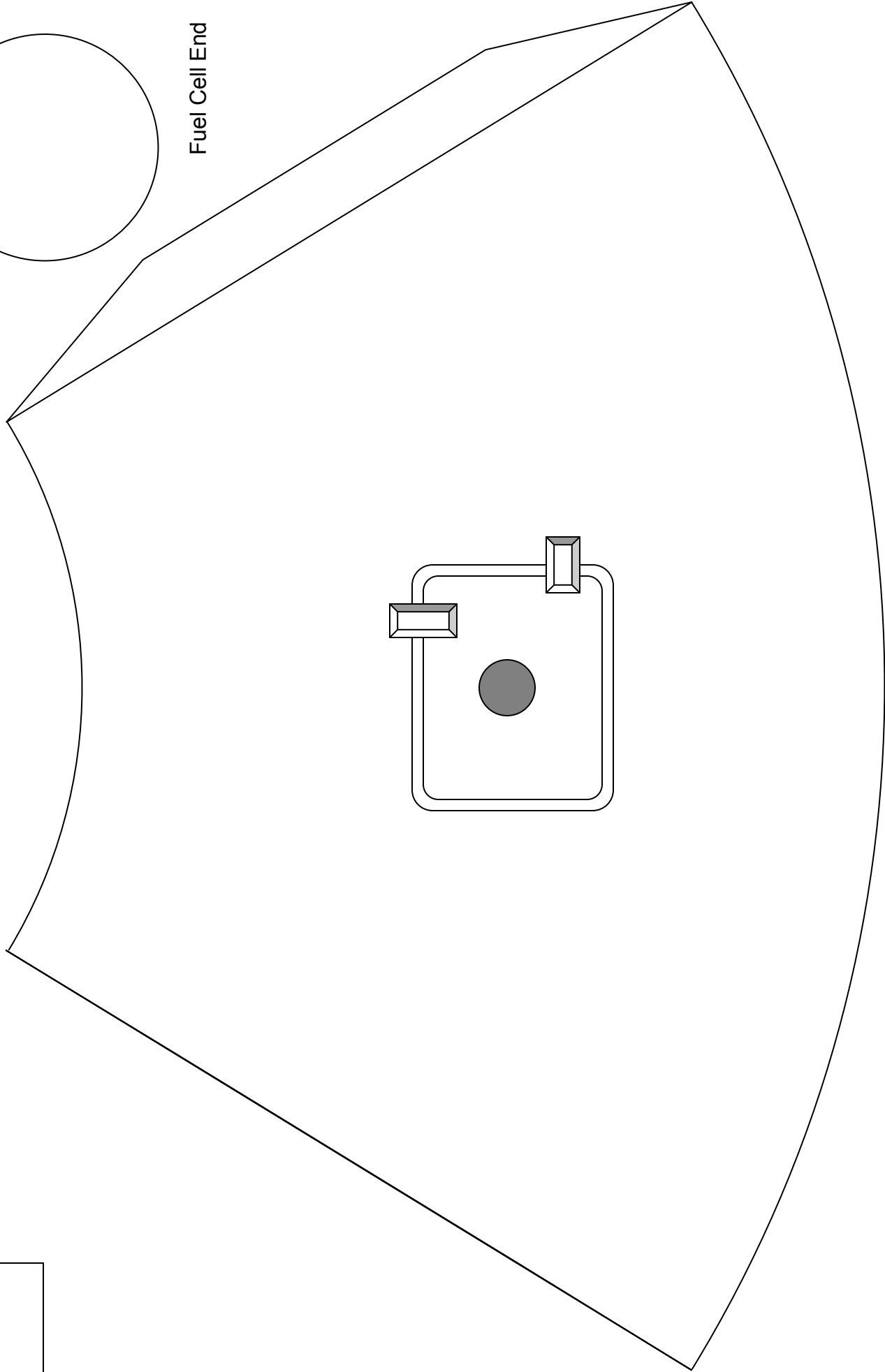

CM shroud 1

1" X 1"

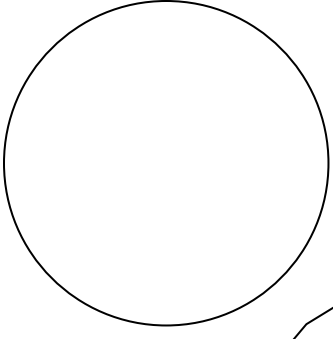

Fuel Cell End

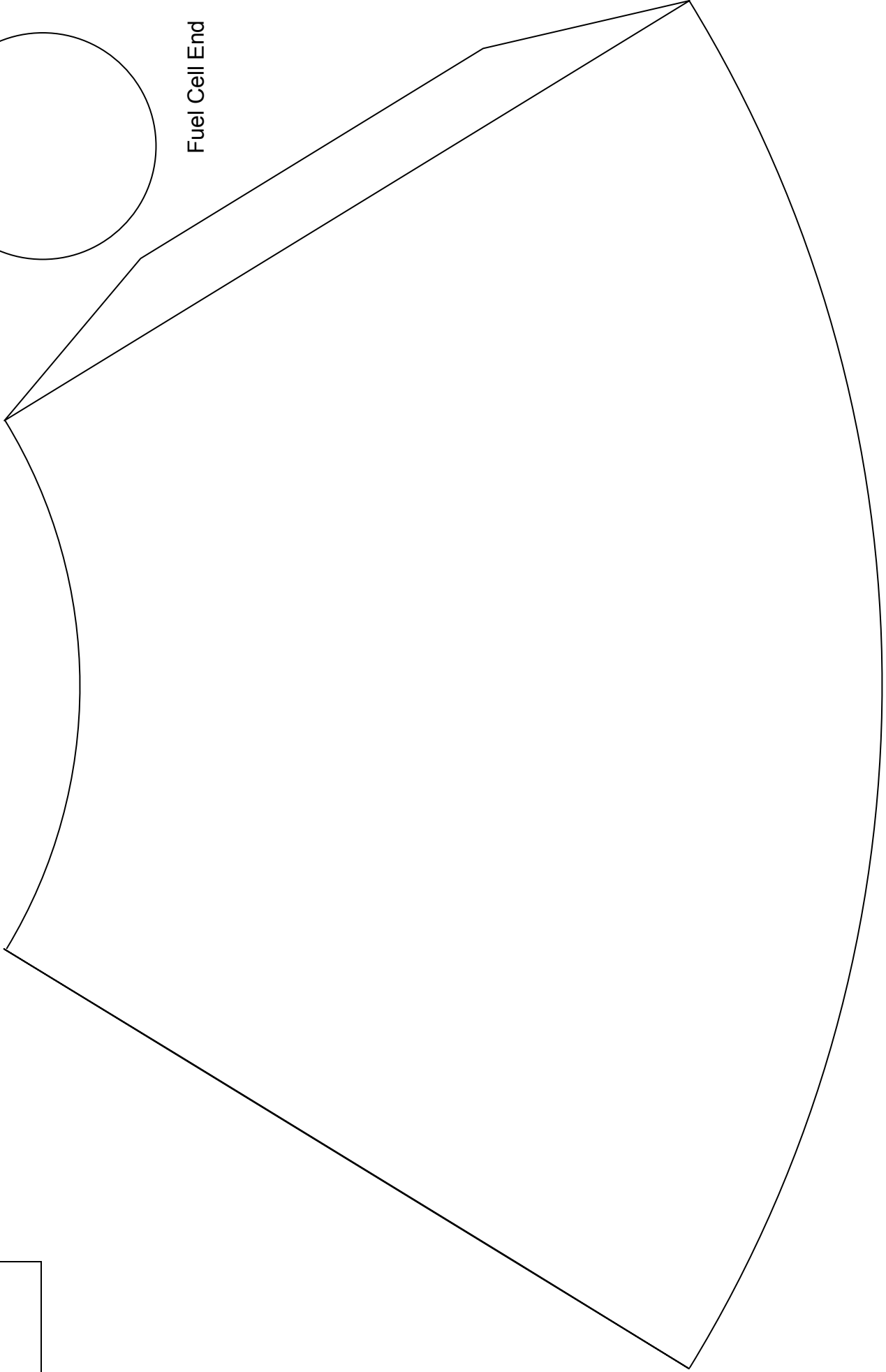

CM shroud 2

1" X 1"

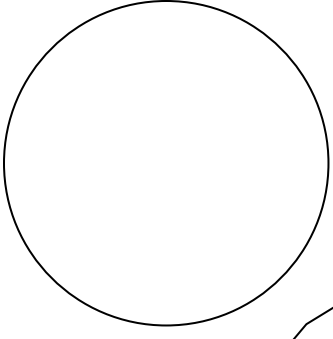

Fuel Cell End

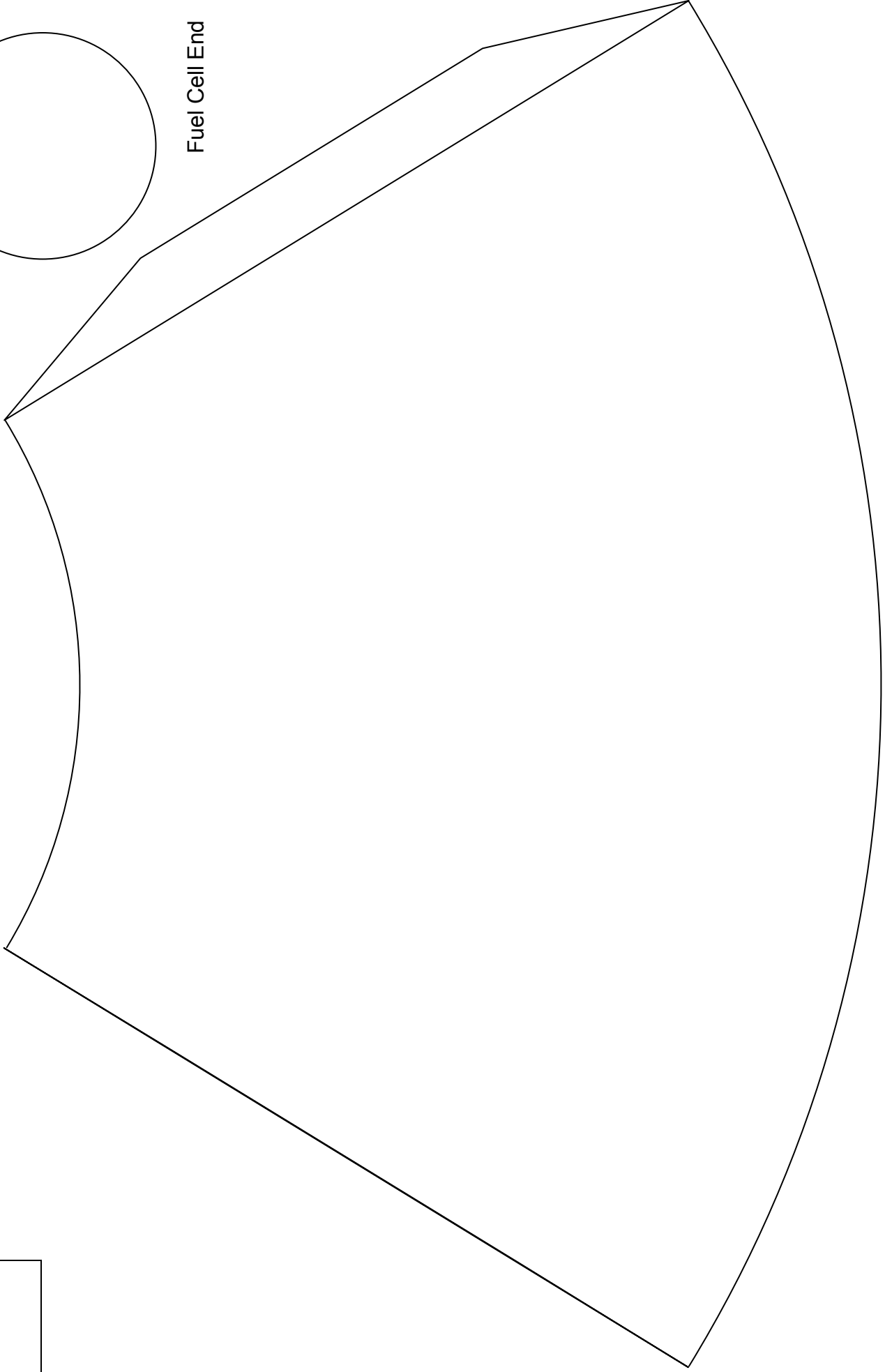

CM shroud 3

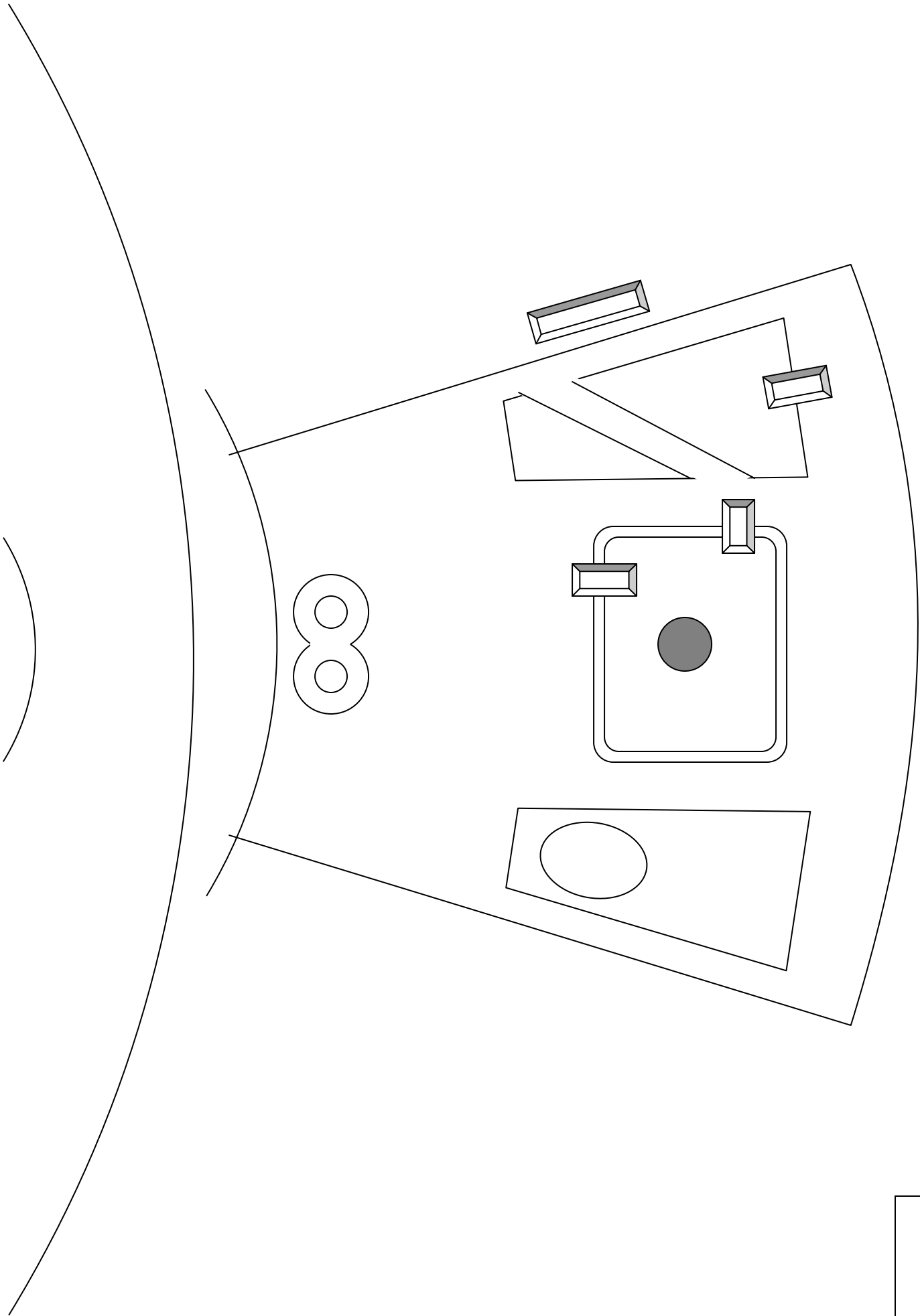

1" X 1"

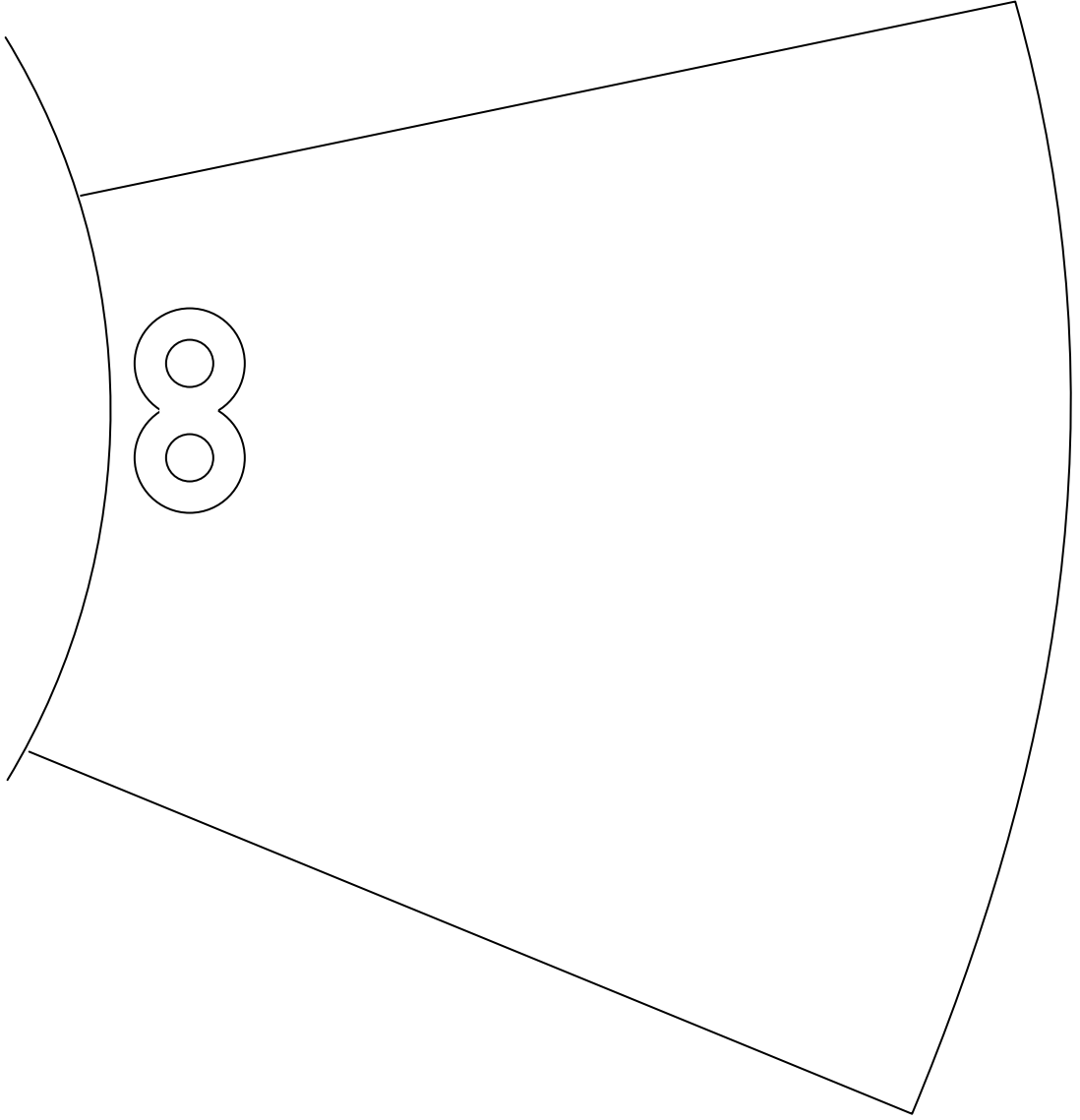
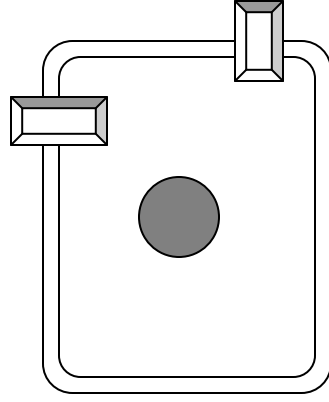
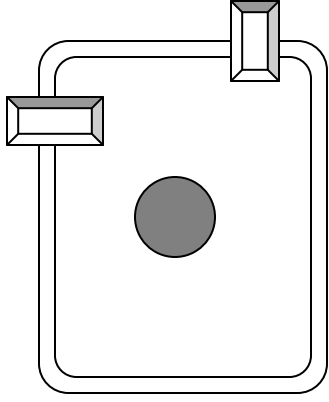

1" X 1"

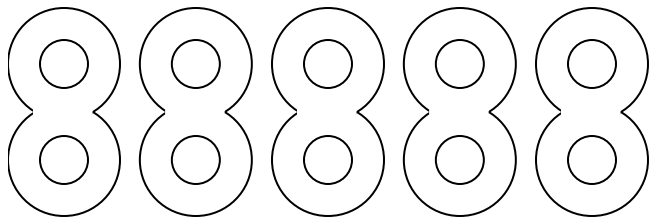

protective
shroud 1

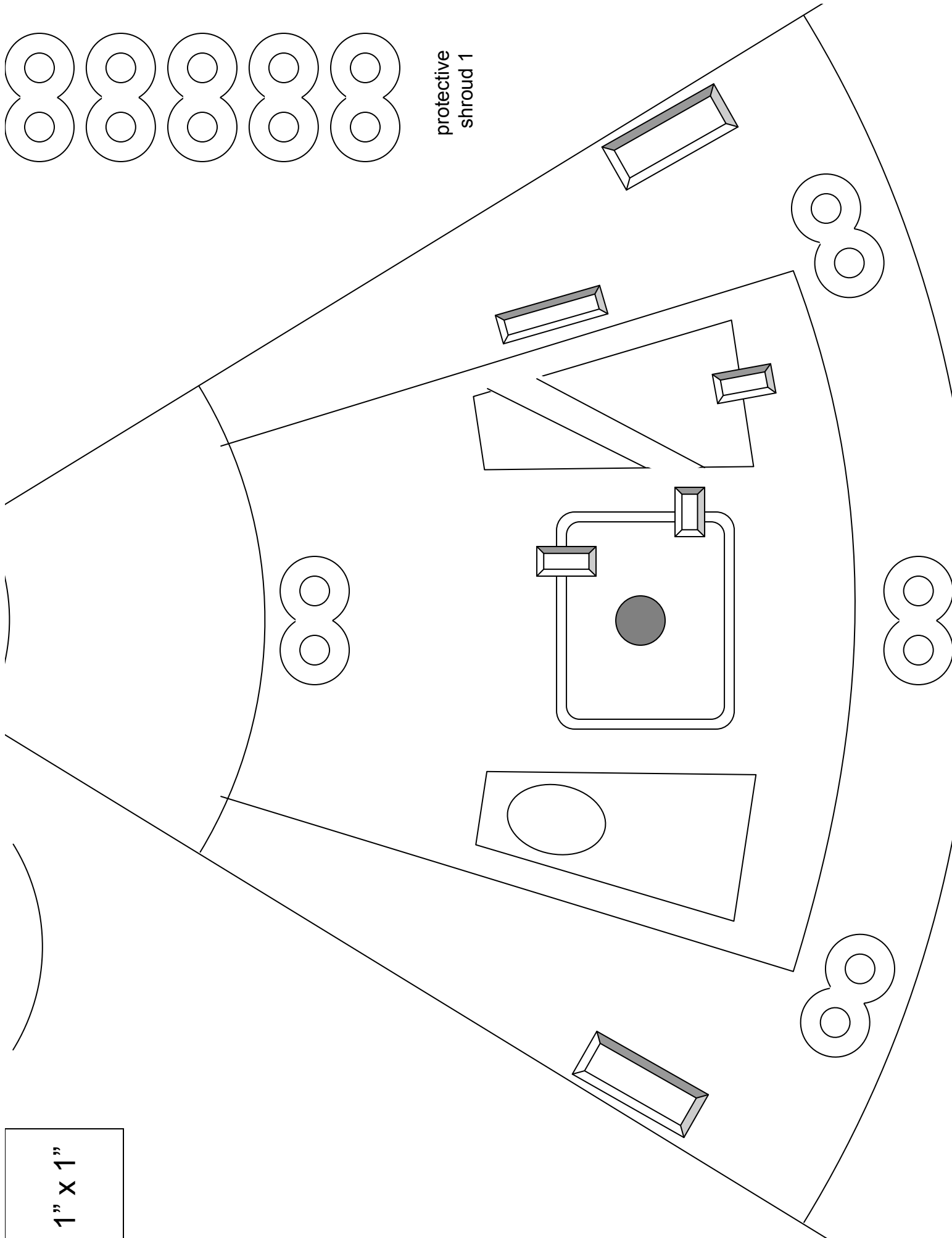

1" X 1"

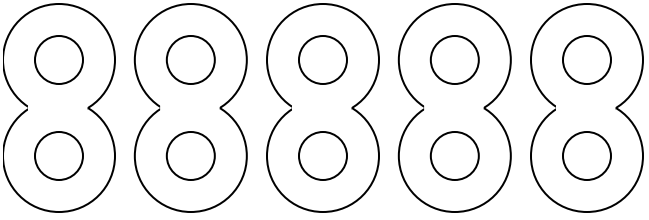

protective
shroud 2

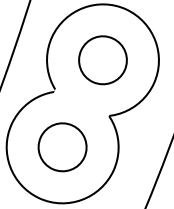
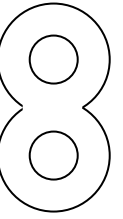
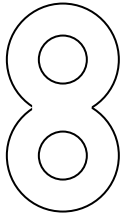
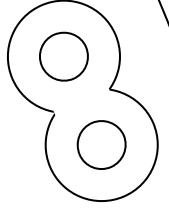
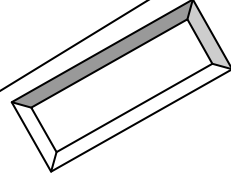

1" X 1"

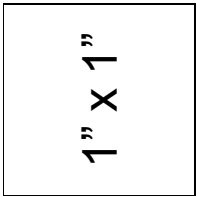

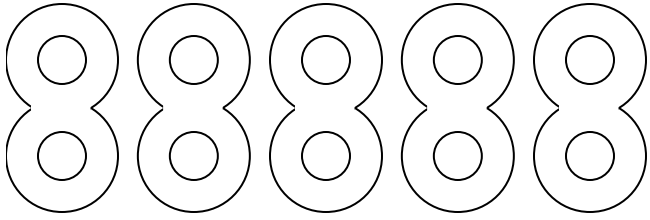

protective
shroud 2

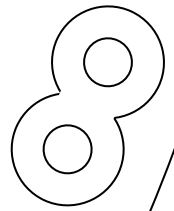
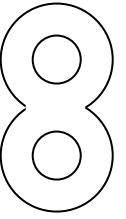
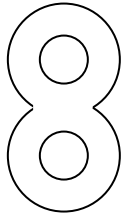
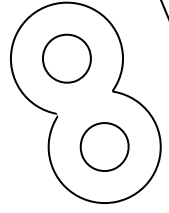
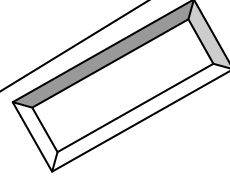

1" X 1"

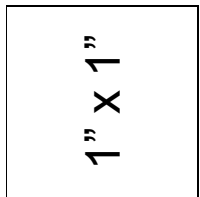

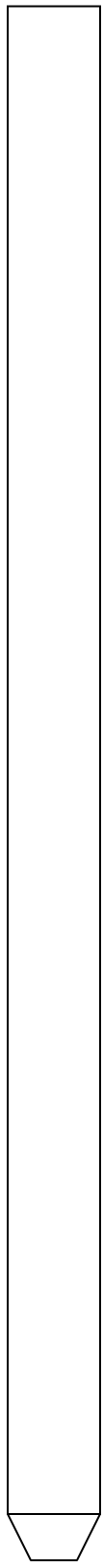
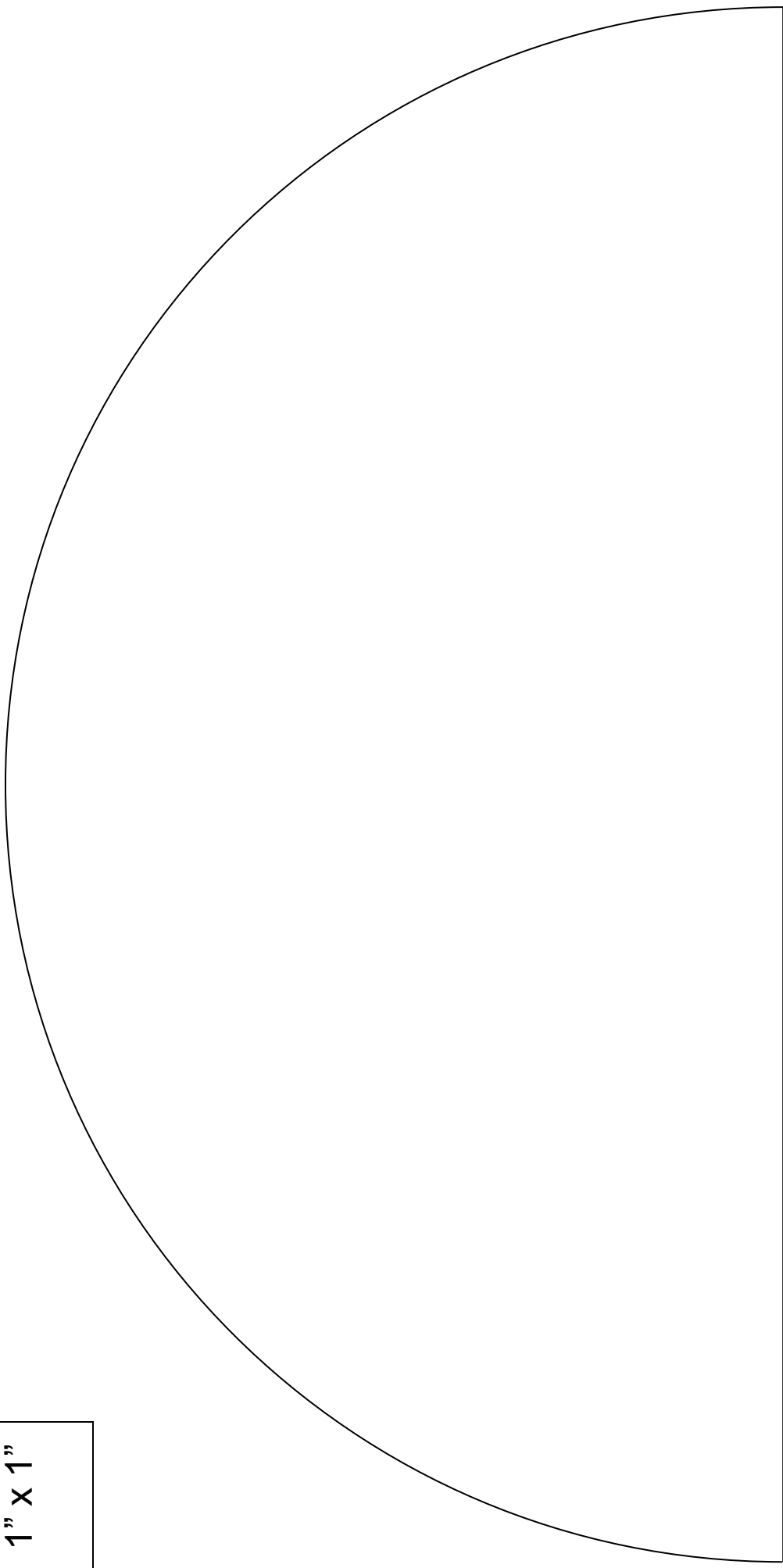

CM base
(print 4)

1" X 1"

Escape tower
Fuel cell upper

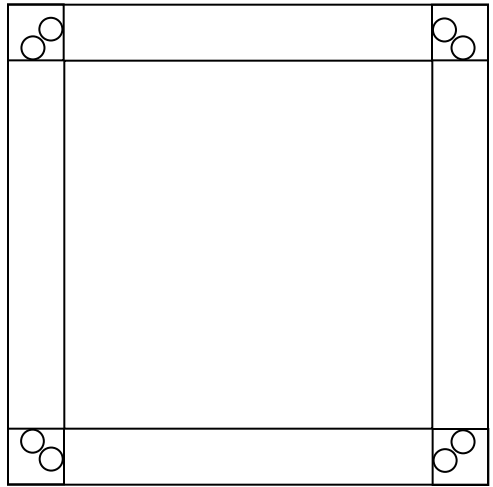
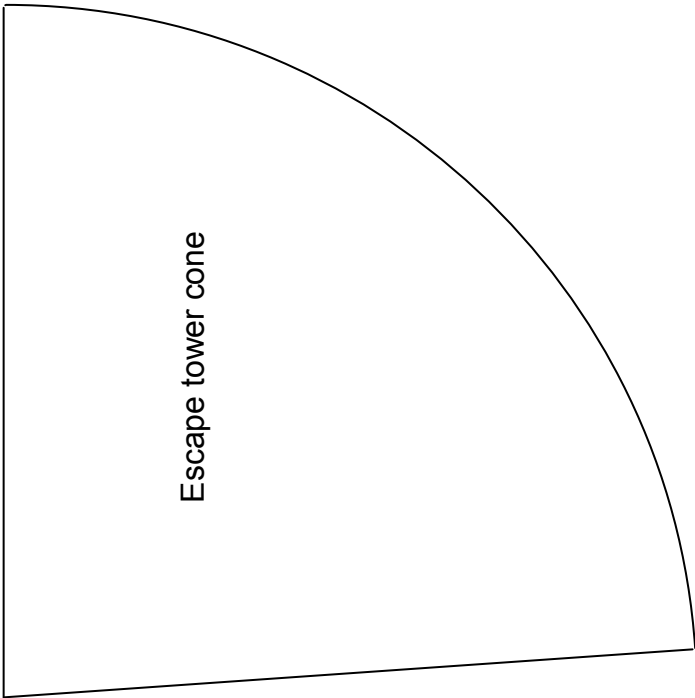
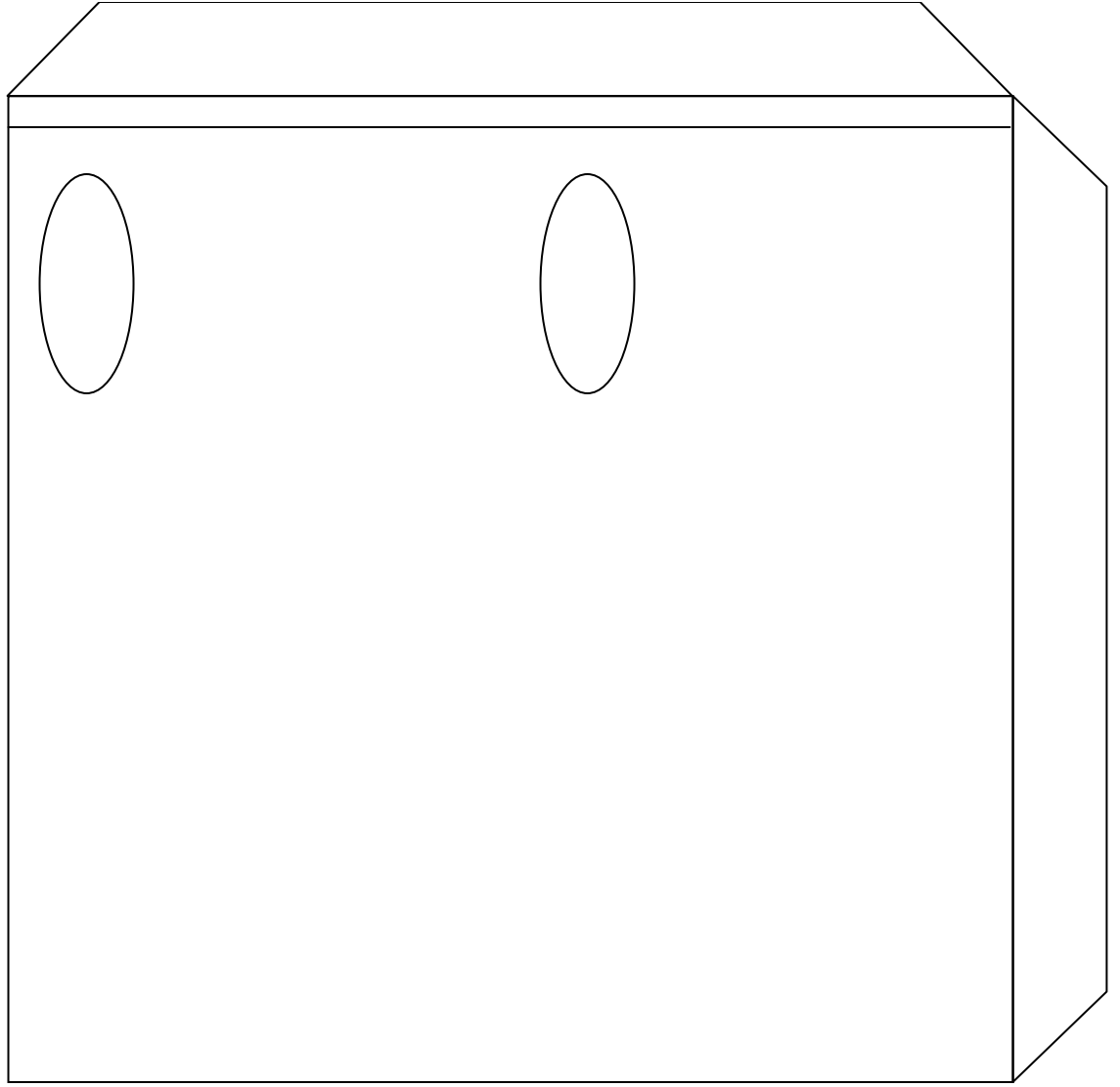

1" X 1"

Escape tower
Fuel cell lower

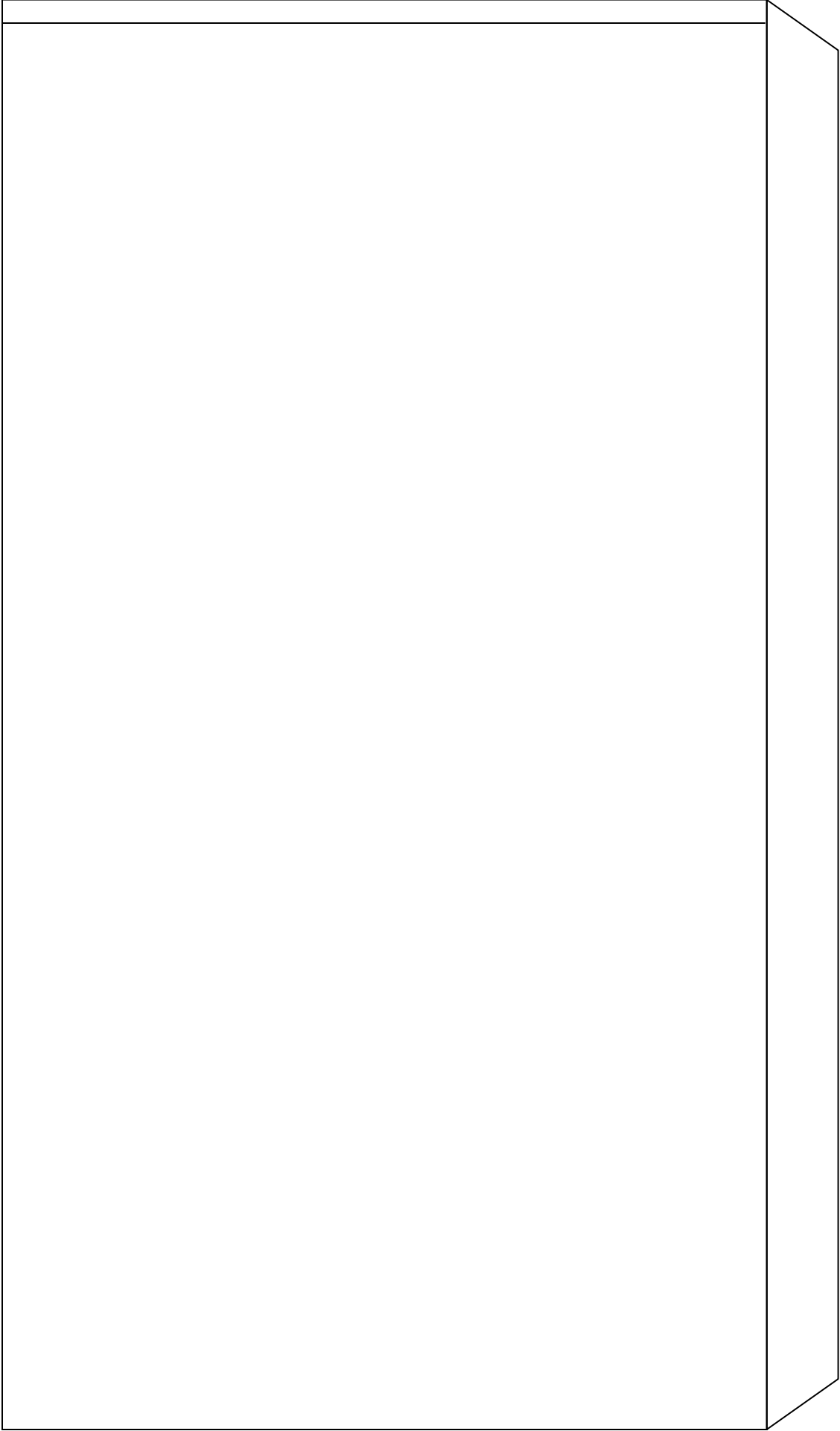

0 50 100 150 200 250 300
INCHES

